



"AVX" and "AVXB" - window/wall



- Axial fans for medium and large rooms
- For walls, ceilings, panels or windows and built-in
- IPX4 - Splashproof
- 6 models, 2 sizes
- Automatic
- Reversible models
- Silent, slow moving shutters
- Exceeds Building Regulations requirements (including new Document F)

GENERAL

- for domestic/commercial use
- to exhaust air directly outside through windows, double glazed windows, walls, ceilings and panels
- for kitchens, larger bathrooms, offices, pubs, restaurants, shops, warehouses, etc
- all automatic models with slow moving, delay action shutters for silent opening and closing
- automatic reversible models complete with 5 speed remote controller which also allows fan shutters to be left open for natural ventilation without security risk
- splashproof (to IPX4)
- suitable for installation in Zones I and II
- built-in models supplied with galvanised steel, telescopic wall liner, internal and external wall grilles and 5 speed controller

SPECIFICATION

- casings formed from shockproof and heat resistant plastics
- motors mounted on self lubricating, sealed for life bearings for long life and quiet running
- motor protected with thermal cut-out
- double insulated
- maximum ambient temperature 40°C

COMPLY WITH

- CEI61/28 - IEC342-1
- EC Low Voltage Directive 73/23-93/68
- EC Directive EMC89/336
- CE marked
- Keymark Approved

RANGE

- **AVX23/9A**
9"/23cm automatic
- **AVX23/9AR**
9"/23cm automatic, reversible
- **AVX30/12A**
12"/30cm automatic
- **AVX30/12AR**
12"/30cm automatic, reversible
- **AVX23/9ARB**
9"/23cm built-in, automatic, reversible
- **AVX30/12ARB**
12"/30cm built-in, automatic, reversible



5 Speed Controller included with all reversible models

TYPICAL SPECIFICATION

Supply and install an AVX30/12AR automatic, reversible window/wall fan as supplied by Vectaire Ltd, Lincoln Road, Cressex Business Park, High Wycombe, Bucks, HP12 3RH.

This fan is to be suitable for installation in domestic or commercial premises into solid or cavity walls, single or double glazed windows or in a ceiling.

It is to be operated by a remote 5 speed controller (included with the fan) which also allows reversibility and the fan shutters to be left open for natural ventilation. The shutters should be of the silent opening, slow moving type. It should be splashproof to IPX4 allowing for installation into Zones I and II. The fan casing should be formed from shockproof and heat resistant plastics and the motor be quiet running and of the shaded pole type mounted on self lubricating, sealed for life bearings for long protected with thermal cut-out.

Fan to comply with all current IEE, EC and Building Regulations requirements and be keymark approved.



Tel: +44(0)1494 522333
Fax: +44(0)1494 522337

Vectaire Ltd
Lincoln Road, Cressex Business Park
High Wycombe, Buckinghamshire, HP12 3RH

Email: sales@vectaire.co.uk
Web: www.vectaire.co.uk

TECHNICAL CHARACTERISTICS

INSTALLATIONS

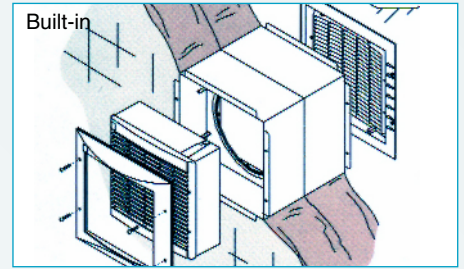
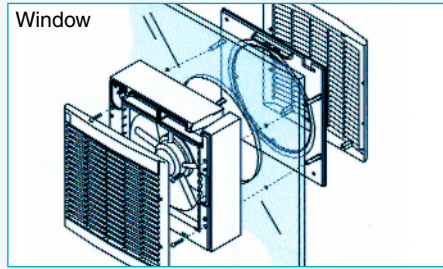
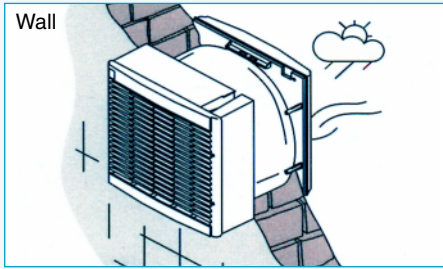

WIRING DIAGRAMS

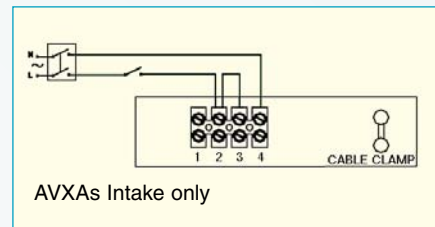
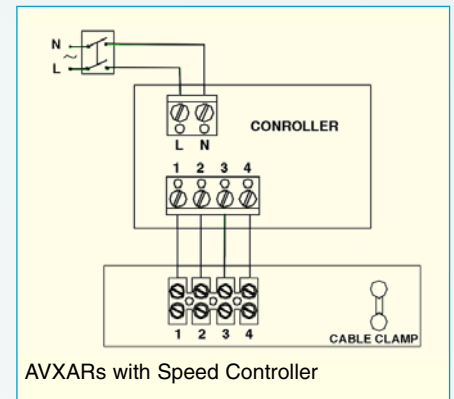
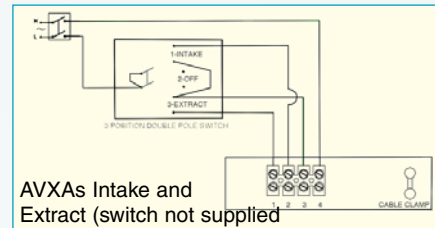
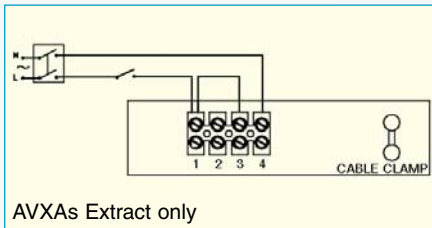

DIMENSIONS

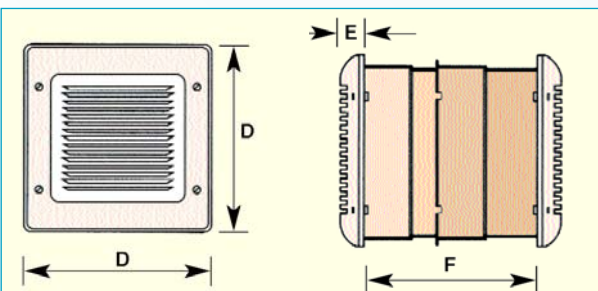
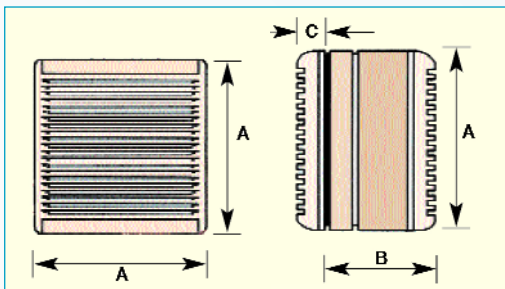

	A	B	C	D	E	F
AVX23/9ARB	340	150	40	415	40	240-315
AVX30/12ARB	420	190	40	495	40	240-315

PRESSURE

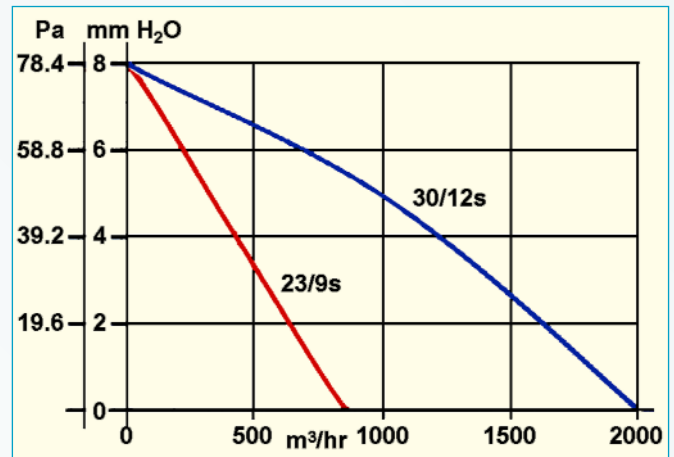

TECHNICAL DATA

Model	Size		Power Watts	Airflow			Sound Max dbA	Hole Size mm	Reversible	Speed Controller included
	in	cm		m³/hr	cfm	l/sec				
AVX23/9A	9	23	45	825	487	229	49	258-260	yes	no
AVX23/9AR	9	23	45	825	487	229	49	258-260	yes	yes
AVX30/12A	12	30	90	1900	1120	528	51	338-340	yes	no
AVX30/12AR	12	30	90	1900	1120	528	51	338-340	yes	yes
AVX23/9ARB	9	23	45	825	487	229	49	370x370	yes	yes
AVX30/12ARB	12	30	90	1900	1120	528	51	450x450	yes	yes

FULL RANGE OF ACCESSORIES AVAILABLE INCLUDING FLEXIBLE AND FLAT DUCTING

Tel: +44(0)1494 522333
Fax: +44(0)1494 522337

Vectaire Ltd
Lincoln Road, Cressex Business Park
High Wycombe, Buckinghamshire, HP12 3RH

Email: sales@vectaire.co.uk
Web: www.vectaire.co.uk